

Matériau : ACIER+HPL

Ref : QA1



4



\*\*\*\* m

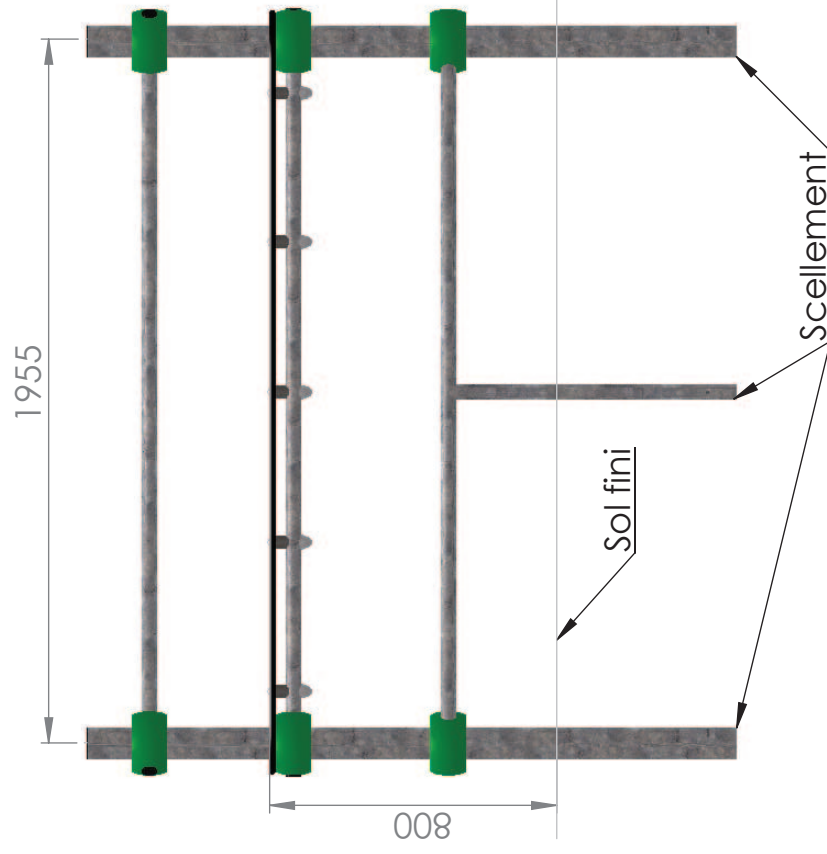
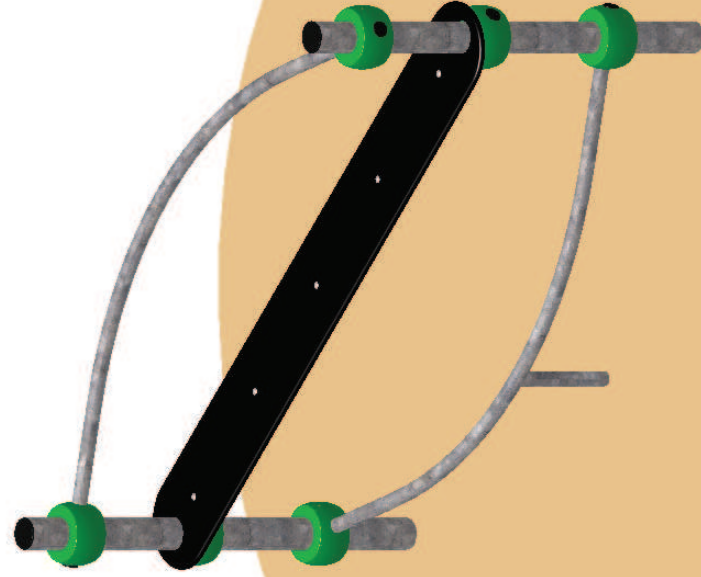

Encombrement du jeu: L 2.15 l 0.80 h 1.30 m

| No. ARTICLE | N° DE SERIE<br>PIECE | NUMERO DE PIECE             | QTE |
|-------------|----------------------|-----------------------------|-----|
| 1           | Q-003                | bouchon                     | 5   |
| 2           | Q-152                | BOUCHON DE COLLIER DIA 88.9 | 48  |
| 3           | Q-006                | chapeau tube 88.9           | 2   |
| 4           | QV-083               | CHC M10x75                  | 24  |
| 5           | Q-153                | DEMI COLLIER DIA 88.9       | 12  |
| 6           | QE-002               | Ecrou frein inox 304 Ø10    | 5   |
| 7           | QE-008               | ECROU NON FREIN Ø10         | 24  |
| 8           | Q-010                | embase                      | 5   |
| 9           | Q-012                | ENTRETOISE L30 INCURVEE     | 5   |
| 10          | Q-099                | Fer à beton L150            | 3   |
| 11          | Q-031                | INSERT DIA 45               | 6   |
| 12          | SQ-024               | QA1-QA2 BANC                | 1   |
| 13          | SQ-025               | QA1-QA2 DOSSIER             | 1   |
| 14          | SQ-030               | QA1-QA2 POTEAU              | 2   |
| 15          | SQ-031               | QA1-QA2 REPOSE-PIEDS        | 1   |
| 16          | SQ-029               | QA1-QA2 SUPPORT BANC        | 1   |
| 17          | QR-001               | rondelle de calage          | 5   |
| 18          | QR-002               | RONDELLE DIA 10             | 5   |
| 19          | QV-061               | TRCC M8X110                 | 5   |

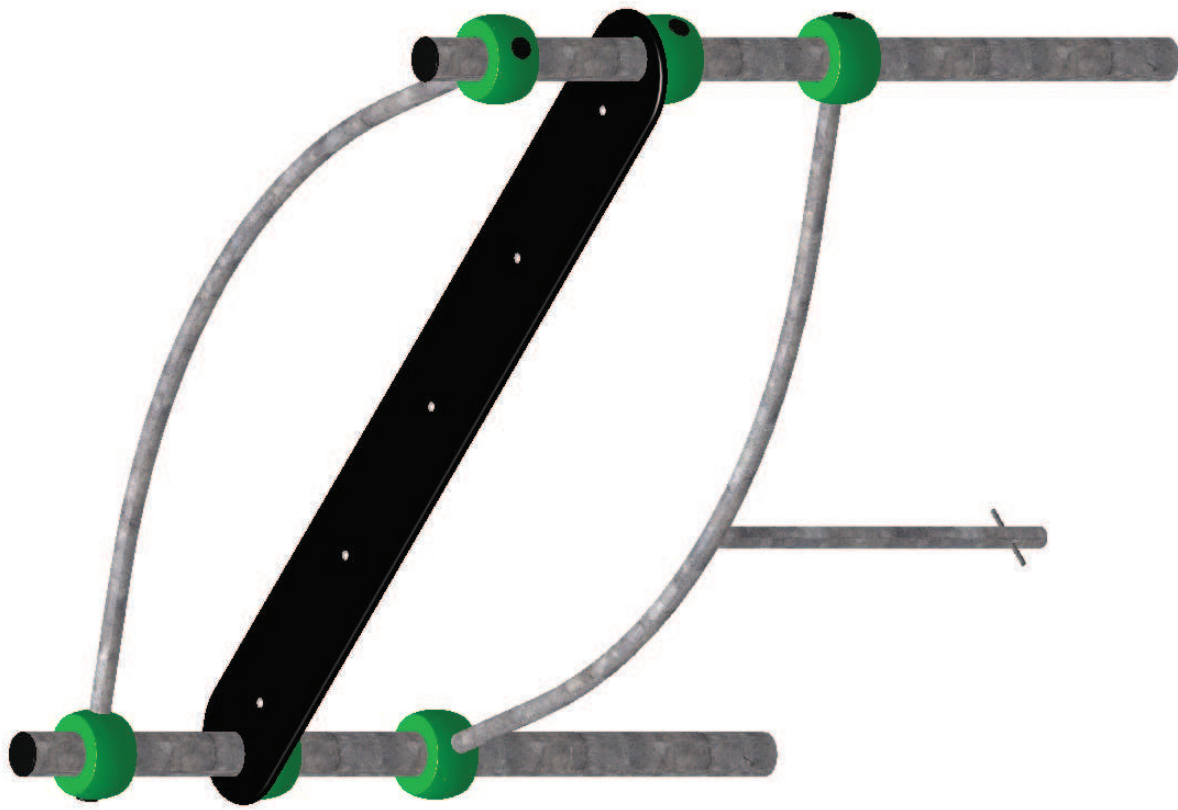

Désignation :

GET UP

Matériau :

ACIER+HPL

Finition :

GALVANISE

Référence : QA1

Dessinateur : MIOTES François

Date : 28/05/2014

Echelle : A4



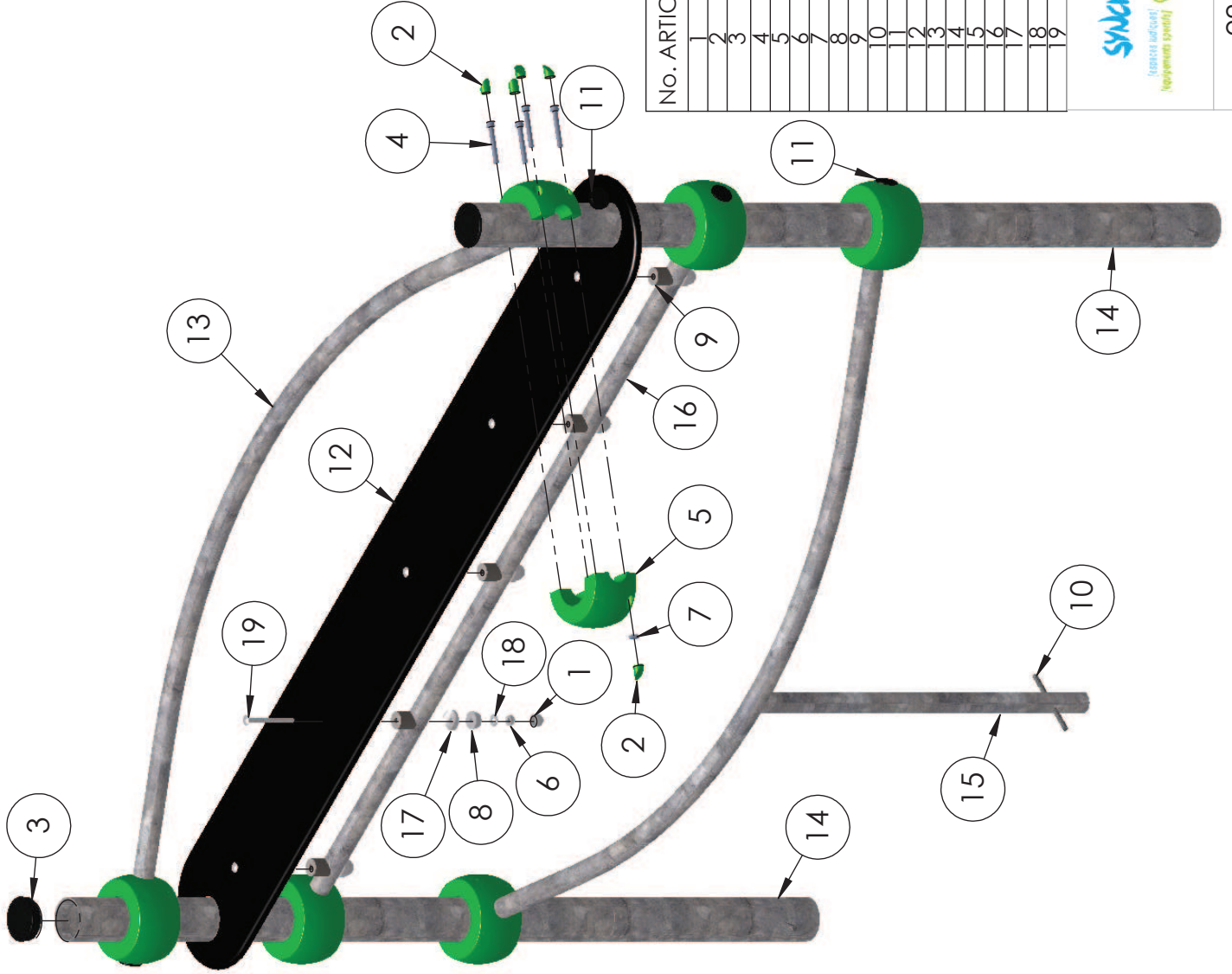

| No. ARTICLE | N° DE SERIE<br>PIECE | NUMERO DE PIECE             | QTE |
|-------------|----------------------|-----------------------------|-----|
| 1           | Q-003                | bouchon                     | 5   |
| 2           | Q-152                | BOUCHON DE COLLIER DIA 88.9 | 48  |
| 3           | Q-006                | chapeau tube 88.9           | 2   |
| 4           | QV-083               | CHC M10x75                  | 24  |
| 5           | Q-153                | DEMI COLLIER DIA 88.9       | 12  |
| 6           | QE-002               | Ecroû frein inox 304 Ø10    | 5   |
| 7           | QE-008               | ECROU NON FREIN Ø10         | 24  |
| 8           | Q-010                | embase                      | 5   |
| 9           | Q-012                | ENTRETOISE L30 INCURVEE     | 5   |
| 10          | Q-099                | Fer alu beton L150          | 3   |
| 11          | Q-031                | INSER DIA 45                | 6   |
| 12          | SQ-024               | QA1-QA2 BANC                | 1   |
| 13          | SQ-025               | QA1-QA2 DOSSIER             | 1   |
| 14          | SQ-030               | QA1-QA2 POTEAU              | 2   |
| 15          | SQ-031               | QA1-QA2 REPOSE-PIEDS        | 1   |
| 16          | SQ-029               | QA1-QA2 SUPPORT BANC        | 1   |
| 17          | QR-001               | rondelle de calage          | 5   |
| 18          | QR-002               | RONDELLE DIA 10             | 5   |
| 19          | QV-061               | TRCC M8x110                 | 5   |

Matière :  
 ACIER+HPL  
 Finition :  
 GALVANISE  
 Référence : QA1  
 Dessinateur : MIOTES François  
 Date : 28/05/2014  
 Echelle : A4



## Scellement en 35 cm

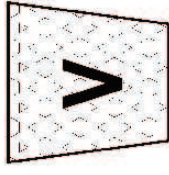

Volume de béton:

0.15 m<sup>3</sup>

( $\mu=250$  kg/m<sup>3</sup>)

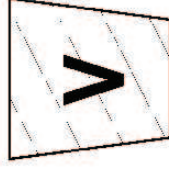

Débais non foisonnés:

0.15 m<sup>3</sup>

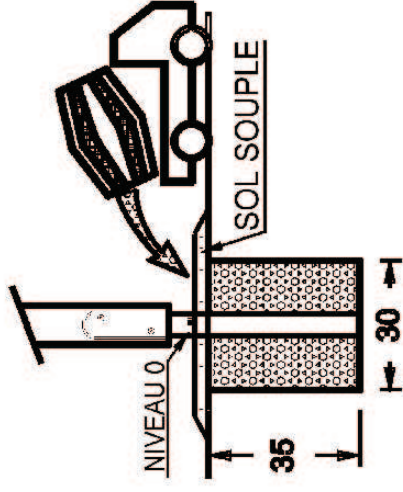

□ : 0.3 m x 0.6 m x 0.35 m

○ : 0.3 m x 0.3 m x 0.35 m

## Scellement 75 Cm pour sol fluant

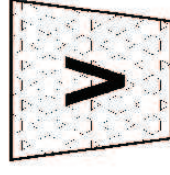

Volume de béton:

0.15 m<sup>3</sup>

( $\mu=250$  kg/m<sup>3</sup>)

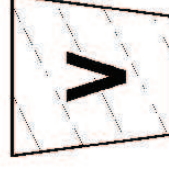

Débais non foisonnés:

0.30 m<sup>3</sup>

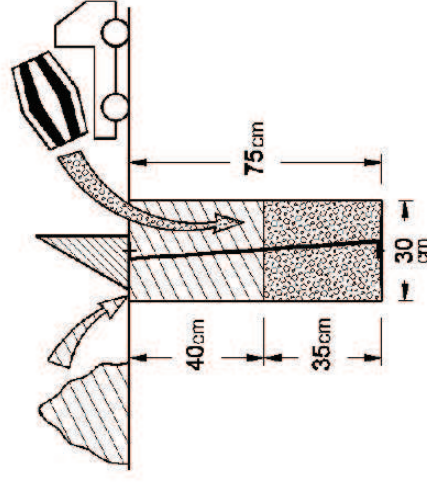

□ : 0.3 m x 0.6 m x 0.75 m

○ : 0.3 m x 0.3 m x 0.75 m

## Montage des modules

Voir éclaté du module



Matériau :

ACIER+HPL

Finition :

Référence : QA1-QA2

GET UP et START ME UP  
fiche terrassement

| No. ARTICLE | N° DE SERIE<br>PIECE | NUMERO DE PIECE             | QTE |
|-------------|----------------------|-----------------------------|-----|
| 1           | Q-152                | BOUCHON DE COLLIER DIA 88.9 | 8   |
| 2           | QV-083               | CHC M10x75                  | 4   |
| 3           | Q-153                | DEMI COLLIER DIA 88.9       | 2   |
| 4           | QE-008               | ECROU NON FREIN Ø10         | 4   |
| 5           | Q-031                | INSERT DIA 45               | 1   |

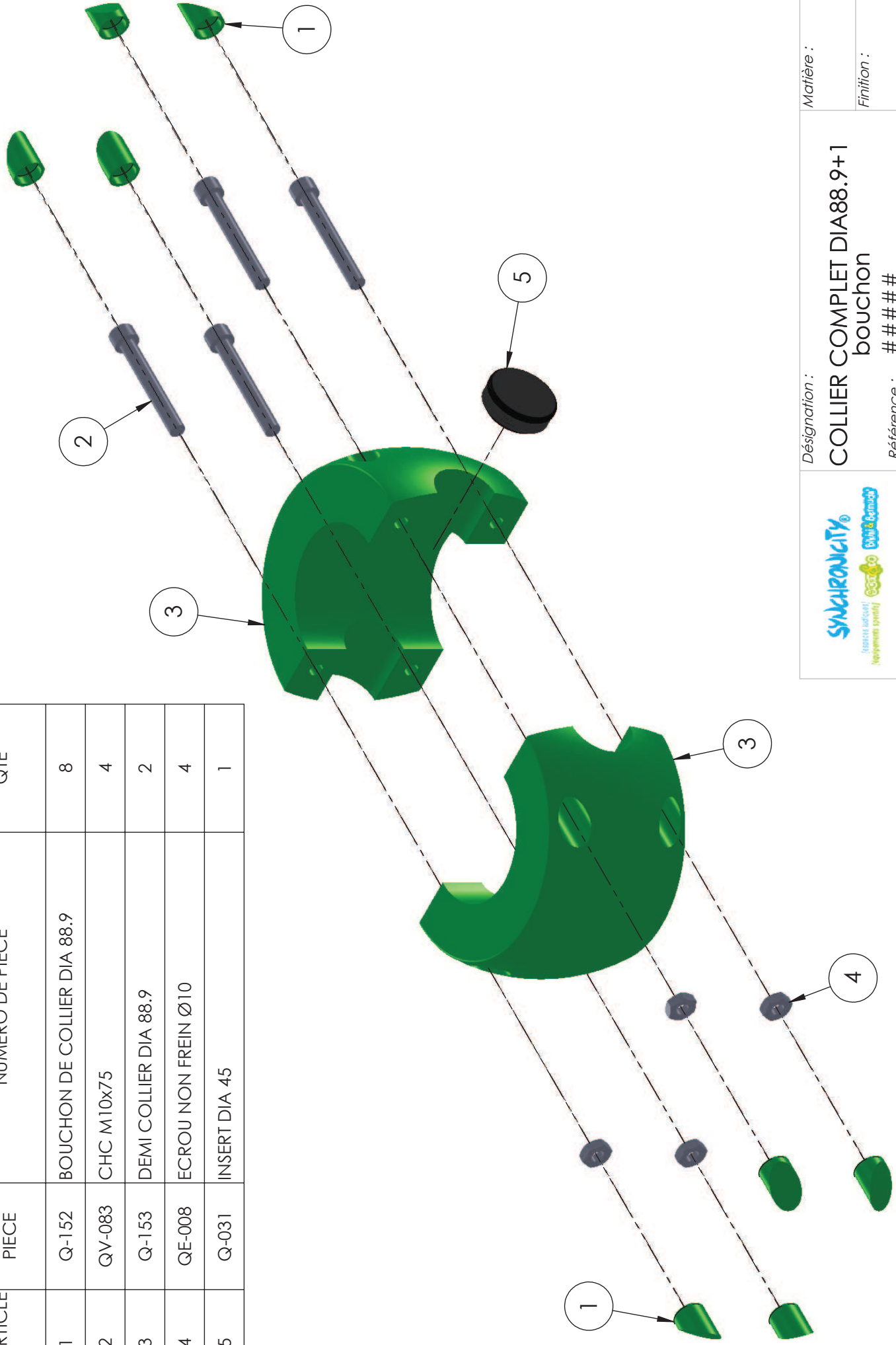

Désignation :

**COLLIER COMPLET DIA88.9+1**  
bouchon  
Référence : ### ##

Matière :

Finition :

Date : 01/10/2013

Dessinateur : MIOTES Français

Echelle : A4

