

RECTO





2 à 8 ans



13



 : Zone de sécurité (minimum normatif) = 24 m²

 : Surface d'impact sur sol fuant = 32.6 m²

 : Hauteur de chute libre = 1 m

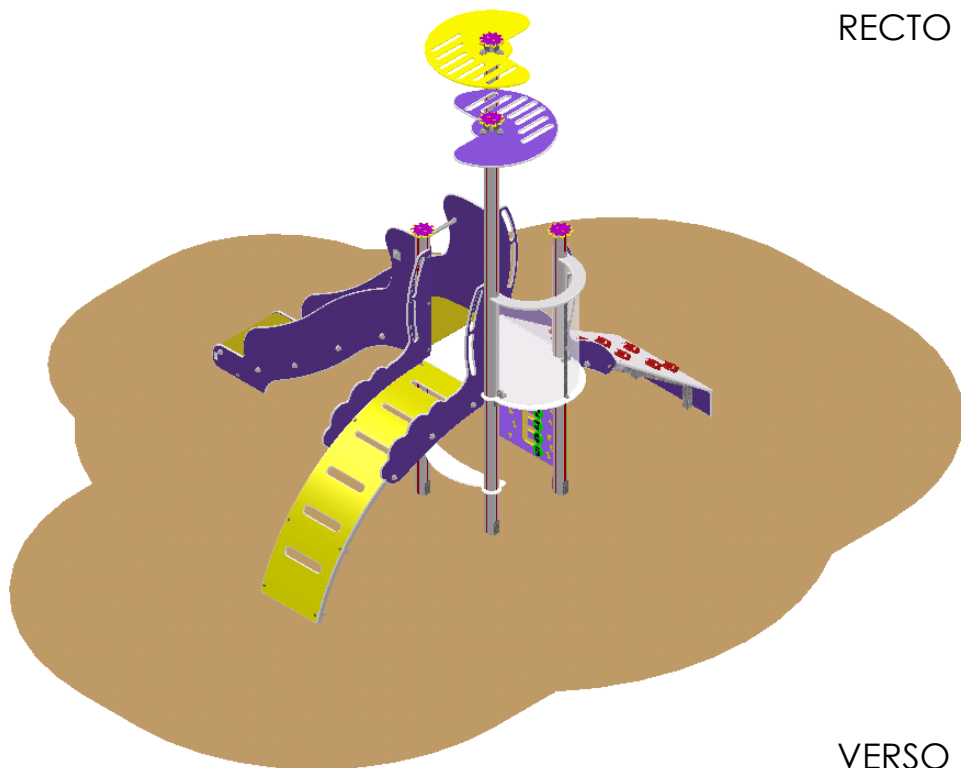

VERSO

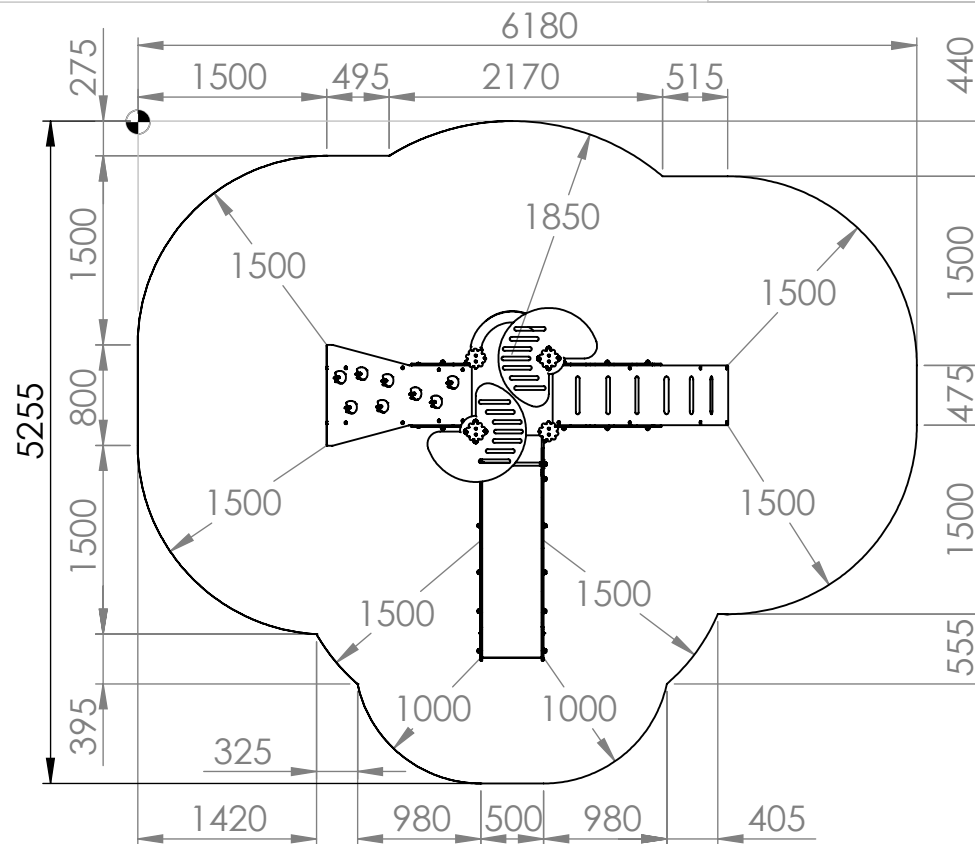
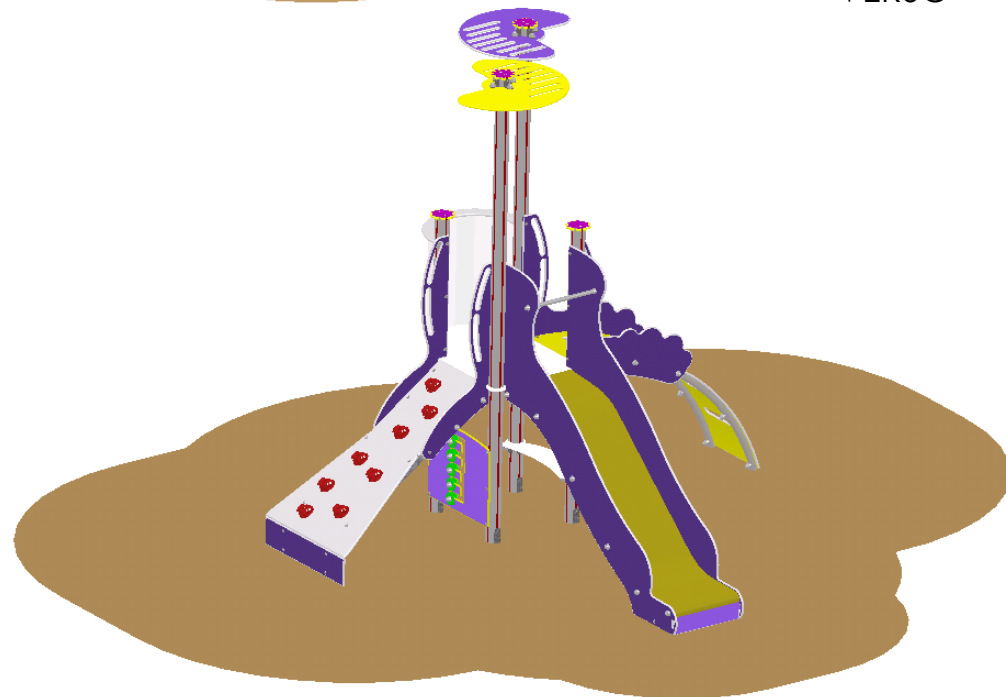

 <small>Technique ludique / équipements sportifs</small>	Désignation :	MINIUM	Matière :	PEHD+POTEAU ALU	
	Référence :	LMN EP15	Finition :		
Date :	14/02/2013	Dessinateur :	MIOTES François	Echelle :	A4